



**2019
DRAPERY
HARDWARE
COLLECTION**

www.selectdraperyhardware.com

Table Of Contents



Select Wood Finishes

	White (50)
	Linen (52)
	Unfinished (76)
	Vintage Gold (23)
	Walnut (55)
	Mahogany (03)
	Bronze (17)
	Mocha (955)
	Black Walnut (47)
	Black (45)
	Antique Pewter (965)
	Platinum (960)
	Charcoal (40)

Select Wood

Holdbacks & Medallions	7
French Returns	9
1 3/8" & 2 1/4" Poles	10
1 3/8" & 2 1/4" End Caps	11
1 3/8" & 2 1/4" Finials	12
1 3/8" & 2 1/4" Accessories	21
1 3/8" & 2 1/4" Rings	22
1 3/8" & 2 1/4" Wood Brackets	23
1 3/8" & 2 1/4" Metal Brackets	24
1 3/8" Iron Image	27



Select Traverse Rods

Select Traverse Rods

Collection begins on page 29.

Select Premium Traverse Rods	32
2 1/4" Select Supreme	
Traverse Rods	33
Traverse Rod Specifications	34
Flat Fascia Traverse Rods	35
Curved & Bent Traverse Rods	37
Custom Mitered Traverse Rods	38
1 3/8" & 2 1/4" Pole	
Combination Brackets	39
Bracket Details	40
Ordering & Specifications	41
Additional Information	42

General Information

Displays and Sales Aids	43
Ordering Information	45

The color photos in this brochure are a close representation of the finishes available. Please refer to your Select Product Binder #2019SWB, or Select Finish Selector #2018SEL for actual finish samples.



**Select Product Binder
2019SWB**



Select Wood Collection

The Select Collection offers a choice of thirteen stunning finishes for poles, traverse rods, brackets, finials, and rings. This collection provides a variety of beautiful drapery hardware and accessories of superior quality with lustrous finishes and amazing detail at prices that cannot compare.





Iron Image

Iron Image offers the look of traditional wrought iron in 1 3/8" diameter wood poles, traverse rods, and finials. The matte, charcoal finish gives the four finial designs and wood poles the look of forged iron. Authentic iron rings and brackets complete the collection.

The **Iron Image** Collection may be viewed on pages 25 to 28.





Select Traverse Rods

Select Traverse Rods feature heavy duty tracks that are constructed with wheeled carriers and metal masters with the capacity to handle today's drapery treatments made with blackout linings and interlinings.

Select Wood Traverse Rods are available in all Select Wood finishes. 1 3/8" and 2 1/4" Traverse Rods are available with the patented Select SureLock® Traverse Ring System. The SureLock Rings® perfectly match the Select full round rings.

The **Select Traverse Rod** Collection may be viewed on pages 29 to 42.







Select Drapery Hardware



Holdbacks & Medallions

Newport
54-784
Resin
3 3/4" Sq.

Omni
53-734
Wood
4" Dia.

Saturn
53-714
Wood
3 3/4" Dia.

Laurel
54-724
Resin
3 3/4" Dia.

Petite Newport
54-782
Resin
2 3/4" Sq.

Petite Omni
53-732
Wood
3" Dia.

Petite Saturn
53-712
Wood
2 3/4" Dia.

Petite Laurel
54-722
Resin
2 3/4" Dia.



White
(50)



Linen
(52)



Vintage Gold
(23)



Walnut
(55)



Mahogany
(03)



Bronze
(17)



Mocha
(955)



Black Walnut
(47)



Black
(45)



Platinum
(960)



Antique Pewter
(965)

Holdbacks & Medallions



Features

- Eight Holdback styles
- Eleven finishes plus unfinished
- Adjustable wood spindles
- Packaged in pairs

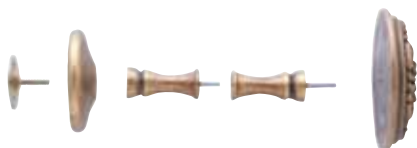

Holdback Side View
2" or 4" spindle projection.



Holdback Side View
2", 4" or 6" spindle
projection.



Shown with 53-002 for
additional 2" projection.
(Sold Separately)



French Returns

Select French Returns are offered in the 1 3/8" Collection in three wood finishes: Black, Bronze, and Black Walnut. The soft curved return is constructed using a combination of wood and metal for support. Select Metal Bracket, 10-203 is recommended to use as a center support for all installations.

1 3/8" wood poles and rings are sold separately.



13-463-17
French Return
Bronze Wood Fascia Finish
with Bronze Metal Return



13-463-45
French Return
Black Wood Fascia Finish
with Black Metal Return



13-463-47
French Return
Black Walnut Wood Fascia
Finish with Bronze
Metal Return



10-203
Metal Bracket

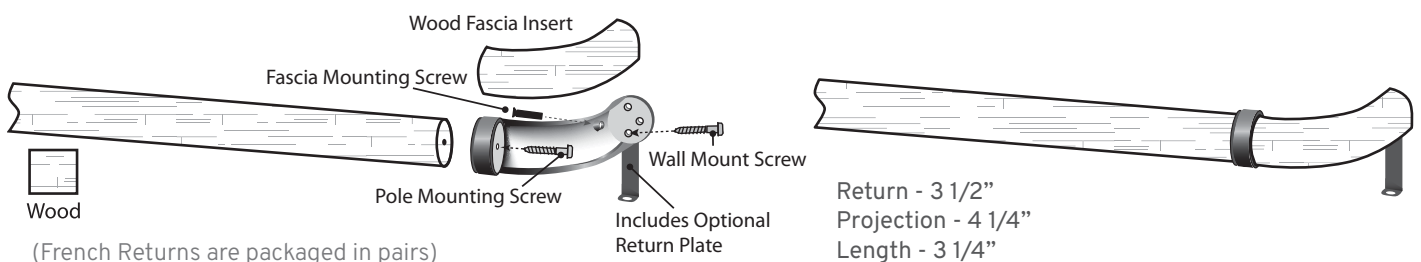

1 3/8" & 2 1/4" Select Poles



White (50) – Reeded Pole
White (50) – Smooth Pole



Walnut (55) – Reeded Pole
Walnut (55) – Smooth Pole



Black Walnut (47) – Reeded Pole
Black Walnut (47) – Smooth Pole



Linen (52) – Reeded Pole
Linen (52) – Smooth Pole



Mahogany (03) – Reeded Pole
Mahogany (03) – Smooth Pole



Black (45) – Reeded Pole
Black (45) – Smooth Pole



Unfinished (76) – Reeded Pole
Unfinished (76) – Smooth Pole



Bronze (17) – Reeded Pole
Bronze (17) – Smooth Pole



Platinum (960) – Reeded Pole
Platinum (960) – Smooth Pole



Vintage Gold (23) – Reeded Pole
Vintage Gold (23) – Smooth Pole



Mocha (955) – Reeded Pole
Mocha (955) – Smooth Pole



Antique Pewter (965) – Reeded Pole
Antique Pewter (965) – Smooth Pole



Charcoal (40) – Smooth Pole
Available in 1 3/8" Iron Image Only

Select Smooth & Reeded Poles

Description	4'	6'	8'	12'
1 3/8" Smooth Pole	11-004	11-006	11-008	11-012
1 3/8" Reeded Pole	12-004	12-006	12-008	12-012
2 1/4" Smooth Pole	21-004	21-006	21-008	21-012
2 1/4" Reeded Pole	22-004	22-006	22-008	22-012



1 3/8" & 2 1/4" End Caps

Select 1 3/8" & 2 1/4" End Caps are packaged in pairs.

Wood End Cap

1 3/8" - 7/8" LX 1 7/8" H
2 1/4" - 1 3/8" LX 3" H



White
13-140-50 (1 3/8")
23-140-50 (2 1/4")



Linen
13-140-52 (1 3/8")
23-140-52 (2 1/4")



Vintage Gold
13-140-23 (1 3/8")
23-140-23 (2 1/4")



Walnut
13-140-55 (1 3/8")
23-140-55 (2 1/4")



Mahogany
13-140-03 (1 3/8")
23-140-03 (2 1/4")



Bronze
13-140-17 (1 3/8")
23-140-17 (2 1/4")



Mocha
13-140-955 (1 3/8")
23-140-955 (2 1/4")



Black Walnut
13-140-47 (1 3/8")
23-140-47 (2 1/4")



Black
13-140-45 (1 3/8")
23-140-45 (2 1/4")



Platinum
13-140-960 (1 3/8")
23-140-960 (2 1/4")



Antique Pewter
13-140-965 (1 3/8")
23-140-965 (2 1/4")

Vesta Wood End Cap

1 3/8" - 1 3/4" LX 2 3/8" H
2 1/4" - 2" LX 3 3/8" H



White
13-145-50 (1 3/8")
23-145-50 (2 1/4")



Linen
13-145-52 (1 3/8")
23-145-52 (2 1/4")



Vintage Gold
13-145-23 (1 3/8")
23-145-23 (2 1/4")



Walnut
13-145-55 (1 3/8")
23-145-55 (2 1/4")



Mahogany
13-145-03 (1 3/8")
23-145-03 (2 1/4")



Bronze
13-145-17 (1 3/8")
23-145-17 (2 1/4")



Mocha
13-145-955 (1 3/8")
23-145-955 (2 1/4")



Black Walnut
13-145-47 (1 3/8")
23-145-47 (2 1/4")



Black
13-145-45 (1 3/8")
23-145-45 (2 1/4")



Platinum
13-145-960 (1 3/8")
23-145-960 (2 1/4")



Antique Pewter
13-145-965 (1 3/8")
23-145-965 (2 1/4")



Charcoal
13-145-40 (1 3/8")

Aries Wood End Cap

1 3/8" - 1 1/4" LX 2 3/8" H
2 1/4" - 2" LX 3 1/4" H



White
13-143R-50 (1 3/8")
23-143-50 (2 1/4")



Linen
13-143R-52 (1 3/8")
23-143-52 (2 1/4")



Vintage Gold
13-143R-23 (1 3/8")
23-143-23 (2 1/4")



Walnut
13-143R-55 (1 3/8")
23-143-55 (2 1/4")



Mahogany
13-143R-03 (1 3/8")
23-143-03 (2 1/4")



Bronze
13-143R-17 (1 3/8")
23-143-17 (2 1/4")



Mocha
13-143R-955 (1 3/8")
23-143-955 (2 1/4")



Black Walnut
13-143R-47 (1 3/8")
23-143-47 (2 1/4")



Black
13-143R-45 (1 3/8")
23-143-45 (2 1/4")



Platinum
13-143R-960 (1 3/8")
23-143-960 (2 1/4")



Antique Pewter
13-143R-965 (1 3/8")
23-143-965 (2 1/4")

Bradford Resin End Cap

1 3/8" - 7/8" LX 1 7/8" H
2 1/4" - 1 3/8" LX 3" H



White
14-144-50 (1 3/8")
24-144-50 (2 1/4")



Linen
14-144-52 (1 3/8")
24-144-52 (2 1/4")



Vintage Gold
14-144-23 (1 3/8")
24-144-23 (2 1/4")



Walnut
14-144-55 (1 3/8")
24-144-55 (2 1/4")



Mahogany
14-144-03 (1 3/8")
24-144-03 (2 1/4")



Bronze
14-144-17 (1 3/8")
24-144-17 (2 1/4")



Mocha
14-144-955 (1 3/8")
24-144-955 (2 1/4")



Black Walnut
14-144-47 (1 3/8")
24-144-47 (2 1/4")



Black
14-144-45 (1 3/8")
24-144-45 (2 1/4")



Platinum
14-144-960 (1 3/8")
24-144-960 (2 1/4")



Antique Pewter
14-144-965 (1 3/8")
24-144-965 (2 1/4")

All end caps are available in Unfinished (76).

1 3/8" & 2 1/4" Finials



Select 1 3/8" Finials are packaged in pairs. Select 2 1/4" Finials are packaged as each.

Imperial Finial - Resin

1 3/8" - 3 5/8" L X 2 3/4" H
2 1/4" - 5 1/2" L X 4 1/4" H



Linen

14-151-52 (1 3/8")
24-151-52 (2 1/4")



Vintage Gold

14-151-23 (1 3/8")
24-151-23 (2 1/4")

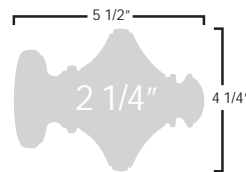

Walnut

14-151-55 (1 3/8")
24-151-55 (2 1/4")



Mahogany

14-151-03 (1 3/8")
24-151-03 (2 1/4")



Bronze

14-151-17 (1 3/8")
24-151-17 (2 1/4")



Mocha

14-151-955 (1 3/8")
24-151-955 (2 1/4")



Black Walnut

14-151-47 (1 3/8")
24-151-47 (2 1/4")



Platinum

14-151-960 (1 3/8")
24-151-960 (2 1/4")



Antique Pewter

14-151-965 (1 3/8")
24-151-965 (2 1/4")

Liberty Finial - Resin

1 3/8" - 4 5/8" L X 2 5/8" H
2 1/4" - 6 1/2" L X 3 5/8" H



Linen

14-127-52 (1 3/8")
24-127-52 (2 1/4")



Vintage Gold

14-127-23 (1 3/8")
24-127-23 (2 1/4")



Walnut

14-127-55 (1 3/8")
24-127-55 (2 1/4")



Mahogany

14-127-03 (1 3/8")
24-127-03 (2 1/4")



Bronze

14-127-17 (1 3/8")
24-127-17 (2 1/4")



Mocha

14-127-955 (1 3/8")
24-127-955 (2 1/4")



Black Walnut

14-127-47 (1 3/8")
24-127-47 (2 1/4")



Platinum

14-127-960 (1 3/8")
24-127-960 (2 1/4")



Antique Pewter

14-127-965 (1 3/8")
24-127-965 (2 1/4")



1 3/8" & 2 1/4" Finials

Select 1 3/8" Finials are packaged in pairs. Select 2 1/4" Finials are packaged as each.

Newport Finial - Resin

1 3/8" - 4 1/2" L X 3 3/8" H
2 1/4" - 6" L X 4 3/8" H



Linen

14-128-52 (1 3/8")
24-128-52 (2 1/4")

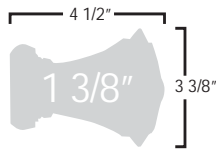

Vintage Gold

14-128-23 (1 3/8")
24-128-23 (2 1/4")



Walnut

14-128-55 (1 3/8")
24-128-55 (2 1/4")



Mahogany

14-128-03 (1 3/8")
24-128-03 (2 1/4")



Bronze

14-128-17 (1 3/8")
24-128-17 (2 1/4")



Mocha

14-128-955 (1 3/8")
24-128-955 (2 1/4")



Black Walnut

14-128-47 (1 3/8")
24-128-47 (2 1/4")



Platinum

14-128-960 (1 3/8")
24-128-960 (2 1/4")



Antique Pewter

14-128-965 (1 3/8")
24-128-965 (2 1/4")

Valencia Finial - Resin

1 3/8" - 4 3/8" L X 2 1/2" H
2 1/4" - 5 3/4" L X 3 3/8" H



Linen

14-126-52 (1 3/8")
24-126-52 (2 1/4")

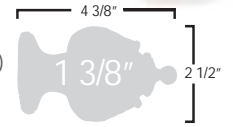

Vintage Gold

14-126-23 (1 3/8")
24-126-23 (2 1/4")

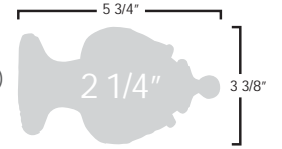

Walnut

14-126-55 (1 3/8")
24-126-55 (2 1/4")



Mahogany

14-126-03 (1 3/8")
24-126-03 (2 1/4")



Bronze

14-126-17 (1 3/8")
24-126-17 (2 1/4")



Mocha

14-126-955 (1 3/8")
24-126-955 (2 1/4")



Black Walnut

14-126-47 (1 3/8")
24-126-47 (2 1/4")



Platinum

14-126-960 (1 3/8")
24-126-960 (2 1/4")



Antique Pewter

14-126-965 (1 3/8")
24-126-965 (2 1/4")

1 3/8" & 2 1/4" Finials



Select 1 3/8" Finials are packaged in pairs. Select 2 1/4" Finials are packaged as each.

Pinecone Finial - Resin

1 3/8" - 4 1/2" L X 2 3/8" H

2 1/4" - 6 1/4" L X 3 1/2" H



Linen

14-115-52 (1 3/8")

24-115-52 (2 1/4")

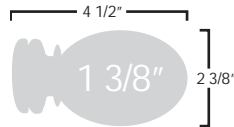

Vintage Gold

14-115-23 (1 3/8")

24-115-23 (2 1/4")

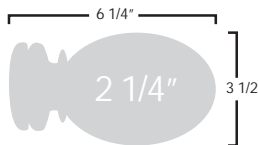

Walnut

14-115-55 (1 3/8")

24-115-55 (2 1/4")



Mahogany

14-115-03 (1 3/8")

24-115-03 (2 1/4")



Bronze

14-115-17 (1 3/8")

24-115-17 (2 1/4")



Mocha

14-115-955 (1 3/8")

24-115-955 (2 1/4")



Black Walnut

14-115-47 (1 3/8")

24-115-47 (2 1/4")



Platinum

14-115-960 (1 3/8")

24-115-960 (2 1/4")



Antique Pewter

14-115-965 (1 3/8")

24-115-965 (2 1/4")

Century Finial - Wood

1 3/8"

2 5/8" L X 2 7/8" H

2 1/4"

3 1/2" L X 3 3/4" H

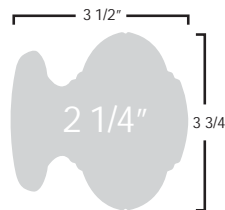
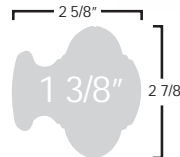

White

13-139-50 (1 3/8")

23-139-50 (2 1/4")



Linen

13-139-52 (1 3/8")

23-139-52 (2 1/4")



Vintage Gold

13-139-23 (1 3/8")

23-139-23 (2 1/4")



Walnut

13-139-55 (1 3/8")

23-139-55 (2 1/4")



Mahogany

13-139-03 (1 3/8")

23-139-03 (2 1/4")



Bronze

13-139-17 (1 3/8")

23-139-17 (2 1/4")



Mocha

13-139-955 (1 3/8")

23-139-955 (2 1/4")



Black Walnut

13-139-47 (1 3/8")

23-139-47 (2 1/4")



Black

13-139-45 (1 3/8")

23-139-45 (2 1/4")



Platinum

13-139-960 (1 3/8")

23-139-960 (2 1/4")



Antique Pewter

13-139-965 (1 3/8")

23-139-965 (2 1/4")

All finials are available in Unfinished (76).



1 3/8" & 2 1/4" Finials

Select 1 3/8" Finials are packaged in pairs. Select 2 1/4" Finials are packaged as each.

Nobel Finial - Wood

1 3/8"
4" L X 2 7/8" H
2 1/4"
5 1/2" L X 3 3/4" H

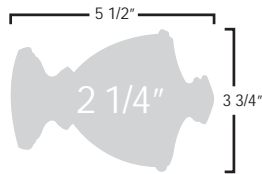
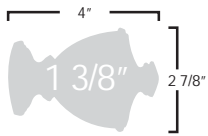

White
13-157-50 (1 3/8")
23-157-50 (2 1/4")



Linen
13-157-52 (1 3/8")
23-157-52 (2 1/4")



Vintage Gold
13-157-23 (1 3/8")
23-157-23 (2 1/4")



Walnut
13-157-55 (1 3/8")
23-157-55 (2 1/4")



Mahogany
13-157-03 (1 3/8")
23-157-03 (2 1/4")



Bronze
13-157-17 (1 3/8")
23-157-17 (2 1/4")



Mocha
13-157-955 (1 3/8")
23-157-955 (2 1/4")



Black Walnut
13-157-47 (1 3/8")
23-157-47 (2 1/4")



Black
13-157-45 (1 3/8")
23-157-45 (2 1/4")



Platinum
13-157-960 (1 3/8")
23-157-960 (2 1/4")



Antique Pewter
13-157-965 (1 3/8")
23-157-965 (2 1/4")

Reeded Ball Finial - Wood

1 3/8"
4" L X 2 3/4" H
2 1/4"
5 3/8" L X 3 3/8" H

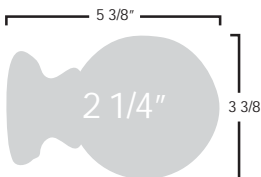
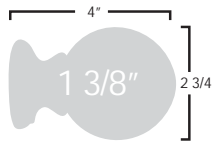

White
13-108-50 (1 3/8")
23-108-50 (2 1/4")



Linen
13-108-52 (1 3/8")
23-108-52 (2 1/4")



Vintage Gold
13-108-23 (1 3/8")
23-108-23 (2 1/4")



Walnut
13-108-55 (1 3/8")
23-108-55 (2 1/4")



Mahogany
13-108-03 (1 3/8")
23-108-03 (2 1/4")



Bronze
13-108-17 (1 3/8")
23-108-17 (2 1/4")



Mocha
13-108-955 (1 3/8")
23-108-955 (2 1/4")



Black Walnut
13-108-47 (1 3/8")
23-108-47 (2 1/4")



Black
13-108-45 (1 3/8")
23-108-45 (2 1/4")



Platinum
13-108-960 (1 3/8")
23-108-960 (2 1/4")



Antique Pewter
13-108-965 (1 3/8")
23-108-965 (2 1/4")

1 3/8" & 2 1/4" Finials



Select 1 3/8" Finials are packaged in pairs. Select 2 1/4" Finials are packaged as each.

Acorn Finial - Wood

1 3/8"
3 7/8" L X 2 3/4" H
2 1/4"
5 3/8" L X 3 3/4" H

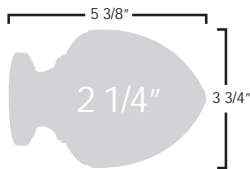

White
13-131-50 (1 3/8")
23-131-50 (2 1/4")



Linen
13-131-52 (1 3/8")
23-131-52 (2 1/4")



Vintage Gold
13-131-23 (1 3/8")
23-131-23 (2 1/4")



Walnut
13-131-55 (1 3/8")
23-131-55 (2 1/4")



Mahogany
13-131-03 (1 3/8")
23-131-03 (2 1/4")



Bronze
13-131-17 (1 3/8")
23-131-17 (2 1/4")



Mocha
13-131-955 (1 3/8")
23-131-955 (2 1/4")



Black Walnut
13-131-47 (1 3/8")
23-131-47 (2 1/4")



Black
13-131-45 (1 3/8")
23-131-45 (2 1/4")



Platinum
13-131-960 (1 3/8")
23-131-960 (2 1/4")



Antique Pewter
13-131-965 (1 3/8")
23-131-965 (2 1/4")

Crown Finial - Wood

1 3/8"
4 1/2" L X 2 3/4" H
2 1/4"
5 7/8" L X 3 5/8" H

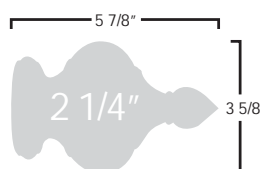
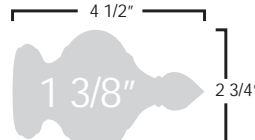

White
13-134-50 (1 3/8")
23-134-50 (2 1/4")



Linen
13-134-52 (1 3/8")
23-134-52 (2 1/4")



Vintage Gold
13-134-23 (1 3/8")
23-134-23 (2 1/4")



Walnut
13-134-55 (1 3/8")
23-134-55 (2 1/4")



Mahogany
13-134-03 (1 3/8")
23-134-03 (2 1/4")



Bronze
13-134-17 (1 3/8")
23-134-17 (2 1/4")



Mocha
13-134-955 (1 3/8")
23-134-955 (2 1/4")



Black Walnut
13-134-47 (1 3/8")
23-134-47 (2 1/4")



Black
13-134-45 (1 3/8")
23-134-45 (2 1/4")



Platinum
13-134-960 (1 3/8")
23-134-960 (2 1/4")



Antique Pewter
13-134-965 (1 3/8")
23-134-965 (2 1/4")

All finials are available in Unfinished (76).



1 3/8" & 2 1/4" Finials

Select 1 3/8" Finials are packaged in pairs. Select 2 1/4" Finials are packaged as each.

Solaris Finial - Wood

1 3/8"
3 1/2" L X 2 7/8" H
2 1/4"
5 1/8" L X 4 1/4" H

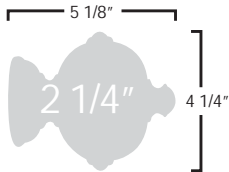
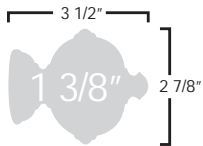

White
13-135-50 (1 3/8")
23-135-50 (2 1/4")



Linen
13-135-52 (1 3/8")
23-135-52 (2 1/4")



Vintage Gold
13-135-23 (1 3/8")
23-135-23 (2 1/4")



Walnut
13-135-55 (1 3/8")
23-135-55 (2 1/4")



Mahogany
13-135-03 (1 3/8")
23-135-03 (2 1/4")



Bronze
13-135-17 (1 3/8")
23-135-17 (2 1/4")



Mocha
13-135-955 (1 3/8")
23-135-955 (2 1/4")



Black Walnut
13-135-47 (1 3/8")
23-135-47 (2 1/4")



Black
13-135-45 (1 3/8")
23-135-45 (2 1/4")



Platinum
13-135-960 (1 3/8")
23-135-960 (2 1/4")



Antique Pewter
13-135-965 (1 3/8")
23-135-965 (2 1/4")

Cambridge Finial - Wood

1 3/8"
4 1/8" L X 2 7/8" H
2 1/4"
5 1/2" L X 3 3/4" H

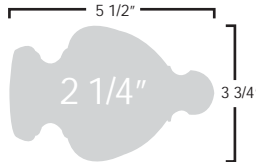
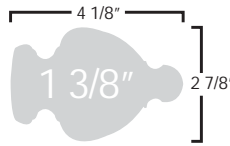

White
13-137-50 (1 3/8")
23-137-50 (2 1/4")



Linen
13-137-52 (1 3/8")
23-137-52 (2 1/4")



Vintage Gold
13-137-23 (1 3/8")
23-137-23 (2 1/4")



Walnut
13-137-55 (1 3/8")
23-137-55 (2 1/4")



Mahogany
13-137-03 (1 3/8")
23-137-03 (2 1/4")



Bronze
13-137-17 (1 3/8")
23-137-17 (2 1/4")



Mocha
13-137-955 (1 3/8")
23-137-955 (2 1/4")



Black Walnut
13-137-47 (1 3/8")
23-137-47 (2 1/4")



Black
13-137-45 (1 3/8")
23-137-45 (2 1/4")



Platinum
13-137-960 (1 3/8")
23-137-960 (2 1/4")



Antique Pewter
13-137-965 (1 3/8")
23-137-965 (2 1/4")

All finials are available in Unfinished (76).

1 3/8" & 2 1/4" Finials



Select 1 3/8" Finials are packaged in pairs. Select 2 1/4" Finials are packaged as each.

Oxford Finial - Wood

1 3/8"
3 1/8" L X 2 3/4" H
2 1/4"
4 1/2" L X 4" H

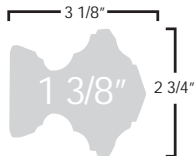

White
13-165-50 (1 3/8")
23-165-50 (2 1/4")



Linen
13-165-52 (1 3/8")
23-165-52 (2 1/4")



Vintage Gold
13-165-23 (1 3/8")
23-165-23 (2 1/4")



Walnut
13-165-55 (1 3/8")
23-165-55 (2 1/4")



Mahogany
13-165-03 (1 3/8")
23-165-03 (2 1/4")



Bronze
13-165-17 (1 3/8")
23-165-17 (2 1/4")



Mocha
13-165-955 (1 3/8")
23-165-955 (2 1/4")



Black Walnut
13-165-47 (1 3/8")
23-165-47 (2 1/4")



Black
13-165-45 (1 3/8")
23-165-45 (2 1/4")



Platinum
13-165-960 (1 3/8")
23-165-960 (2 1/4")



Antique Pewter
13-165-965 (1 3/8")
23-165-965 (2 1/4")

Prescott Finial - Wood

13/8"
3 1/2" L X 3" H
2 1/4"
5" L X 4" H



White
13-105-50 (1 3/8")
23-105-50 (2 1/4")



Linen
13-105-52 (1 3/8")
23-105-52 (2 1/4")



Vintage Gold
13-105-23 (1 3/8")
23-105-23 (2 1/4")



Walnut
13-105-55 (1 3/8")
23-105-55 (2 1/4")



Mahogany
13-105-03 (1 3/8")
23-105-03 (2 1/4")



Bronze
13-105-17 (1 3/8")
23-105-17 (2 1/4")



Mocha
13-105-955 (1 3/8")
23-105-955 (2 1/4")



Black Walnut
13-105-47 (1 3/8")
23-105-47 (2 1/4")



Black
13-105-45 (1 3/8")
23-105-45 (2 1/4")



Platinum
13-105-960 (1 3/8")
23-105-960 (2 1/4")



Antique Pewter
13-105-965 (1 3/8")
23-105-965 (2 1/4")

All finials are available in Unfinished (76).



1 3/8" & 2 1/4" Finials

Select 1 3/8" Finials are packaged in pairs. Select 2 1/4" Finials are packaged as each.

Westwood Finial - Wood

1 3/8"
 3 1/2" L X 2 3/4" H
 2 1/4"
 4 3/4" L X 3 3/4" H

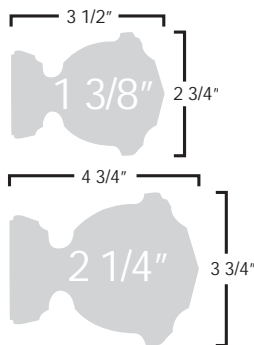

White
 13-138-50 (1 3/8")
 23-138-50 (2 1/4")



Linen
 13-138-52 (1 3/8")
 23-138-52 (2 1/4")

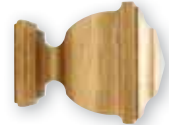

Vintage Gold
 13-138-23 (1 3/8")
 23-138-23 (2 1/4")



Walnut
 13-138-55 (1 3/8")
 23-138-55 (2 1/4")



Mahogany
 13-138-03 (1 3/8")
 23-138-03 (2 1/4")



Bronze
 13-138-17 (1 3/8")
 23-138-17 (2 1/4")



Mocha
 13-138-955 (1 3/8")
 23-138-955 (2 1/4")



Black Walnut
 13-138-47 (1 3/8")
 23-138-47 (2 1/4")



Black
 13-138-45 (1 3/8")
 23-138-45 (2 1/4")



Platinum
 13-138-960 (1 3/8")
 23-138-960 (2 1/4")



Antique Pewter
 13-138-965 (1 3/8")
 23-138-965 (2 1/4")



Charcoal
 13-138-40 (1 3/8")

Ball Finial - Wood

1 3/8"
 3 3/8" L X 2 3/8" H
 2 1/4"
 5" L X 3 5/8" H

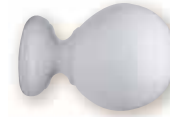
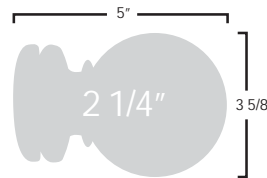
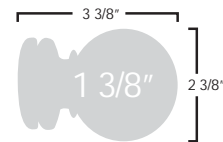

White
 13-101-50 (1 3/8")
 23-101-50 (2 1/4")



Linen
 13-101-52 (1 3/8")
 23-101-52 (2 1/4")



Vintage Gold
 13-101-23 (1 3/8")
 23-101-23 (2 1/4")



Walnut
 13-101-55 (1 3/8")
 23-101-55 (2 1/4")



Mahogany
 13-101-03 (1 3/8")
 23-101-03 (2 1/4")



Bronze
 13-101-17 (1 3/8")
 23-101-17 (2 1/4")



Mocha
 13-101-955 (1 3/8")
 23-101-955 (2 1/4")



Black Walnut
 13-101-47 (1 3/8")
 23-101-47 (2 1/4")



Black
 13-101-45 (1 3/8")
 23-101-45 (2 1/4")



Platinum
 13-101-960 (1 3/8")
 23-101-960 (2 1/4")



Antique Pewter
 13-101-965 (1 3/8")
 23-101-965 (2 1/4")



Charcoal
 13-101-40 (1 3/8")

1 3/8" & 2 1/4" Finials



Select 1 3/8" Finials are packaged in pairs. Select 2 1/4" Finials are packaged as each.

Mission Finial - Wood

1 3/8"
3 1/2" L X 2 7/8" H
2 1/4"
5 1/4" L X 3 3/4" H

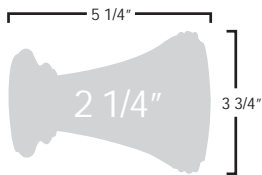
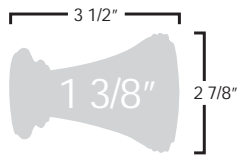









-  **White**
13-133-50 (1 3/8")
23-133-50 (2 1/4")
-  **Linen**
13-133-52 (1 3/8")
23-133-52 (2 1/4")
-  **Vintage Gold**
13-133-23 (1 3/8")
23-133-23 (2 1/4")
-  **Walnut**
13-133-55 (1 3/8")
23-133-55 (2 1/4")
-  **Mahogany**
13-133-03 (1 3/8")
23-133-03 (2 1/4")
-  **Bronze**
13-133-17 (1 3/8")
23-133-17 (2 1/4")
-  **Mocha**
13-133-955 (1 3/8")
23-133-955 (2 1/4")
-  **Black Walnut**
13-133-47 (1 3/8")
23-133-47 (2 1/4")
-  **Black**
13-133-45 (1 3/8")
23-133-45 (2 1/4")
-  **Platinum**
13-133-960 (1 3/8")
23-133-960 (2 1/4")
-  **Antique Pewter**
13-133-965 (1 3/8")
23-133-965 (2 1/4")
-  **Charcoal**
13-133-40 (1 3/8")

Traditional Finial - Wood

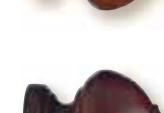
1 3/8"
3 1/2" L X 2 3/8" H

1 3/8" ONLY



-  **White**
13-104-50 (1 3/8")
-  **Linen**
13-104-52 (1 3/8")
-  **Vintage Gold**
13-104-23 (1 3/8")
-  **Walnut**
13-104-55 (1 3/8")
-  **Mahogany**
13-104-03 (1 3/8")
-  **Bronze**
13-104-17 (1 3/8")
-  **Mocha**
13-104-955 (1 3/8")
-  **Black Walnut**
13-104-47 (1 3/8")
-  **Black**
13-104-45 (1 3/8")
-  **Platinum**
13-104-960 (1 3/8")
-  **Antique Pewter**
13-104-965 (1 3/8")

All finials are available in Unfinished (76).



Finials & Accessories

Regal Finial - Wood

2 1/4"
6" L X 3 3/4" H

2 1/4" ONLY

Select 2 1/4" Finials are packaged as each.

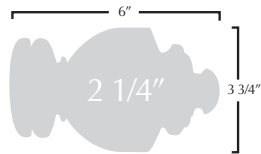

White
23-103-50 (2 1/4")



Linen
23-103-52 (2 1/4")



Vintage Gold
23-103-23 (2 1/4")



Walnut
23-103-55 (2 1/4")



Mahogany
23-103-03 (2 1/4")



Bronze
23-103-17 (2 1/4")



Mocha
23-103-955 (2 1/4")



Black Walnut
23-103-47 (2 1/4")



Black
23-103-45 (2 1/4")



Platinum
23-103-960 (2 1/4")



Antique Pewter
23-103-965 (2 1/4")

1 3/8" Inside Mount Socket

13-450
Available In All Finishes
(Sold in pairs)



1 3/8" Swivel Socket

13-453
Available In All Finishes
(Sold as each)

Wood Batons

53-470
36" Wood Baton
Finishes: 03, 17, 23, 45, 47,
50, 52, 55, 76, 955

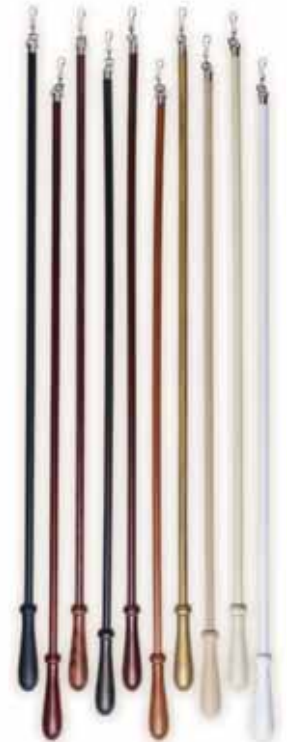

Connector Screw

10-499
1 3/8" Connector Screw
For Use With 1 3/8" Poles
Finish: 91 (Zinc)
20-499
2 1/4" Connector Screw
For Use With 2 1/4" Poles
Finish: 91 (Zinc)



Clip for Ring

50-399-91 (Zinc)
50-399-45
Clips are sold separately

Rings



1 3/8" Smooth Wood Rings

13-300
I.D. 1 7/8", O.D. 2 7/8"
Available In All Finishes
(7 Rings per package)

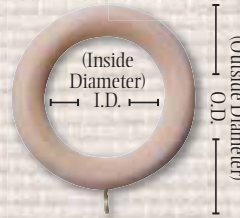

2 1/4" Ribbed Wood Rings

23-345
2 5/8" I.D., 4 1/4" O.D.
Available in All Finishes
(4 Rings per package)



2 1/4" Bradford Resin Rings

24-344
3 1/4" I.D., 4 5/8" O.D.
Finishes: 03, 17, 23, 47,
52, 55, 955, 960, 965
(4 Rings per package)



1 3/8" Iron Rings

10-370-40 - 1 3/8"
1 3/4" I.D., 2 1/2" O.D.
(7 Rings per package)



2 1/4" Iron Rings

20-370-40 - 2 1/4"
2 1/2" I.D., 3 1/4" O.D.
(7 Rings per package)

1 3/8" Metal Rings

10-300 - 1 3/8"
I.D. 1 3/4", O.D. 2 1/4"
Finishes: 17, 23, 45, 50
(7 Rings per package)

2 1/4" Metal Rings

20-300 - 2 1/4"
I.D. 2 5/8", O.D. 3 1/8"
Finishes: 17, 23, 45, 50
(7 Rings per package)



Unfinished rings are available in bulk pack quantities.



1 3/8" Traditional Bracket

13-203 13-206
3 3/4" H, 3 1/2" Return 3 3/4" H, 6" Return
Available In All Finishes
(Sold in pairs)



1 3/8" Double Bracket

13-236
4" H, 2 3/4" & 6" Return Finishes: 03, 17, 23, 45,
1 3/8" Front Pole 47, 50, 52, 55, 76, 955
1 3/8" Back Pole (Sold in pairs)



1 3/8" European Bracket

13-223
2 1/2" H, 3 1/2" Return
Available In All Finishes
(Sold in pairs)

1 3/8" & 2 1/4" Wood Brackets



2 1/4" Traditional Bracket

23-204 23-207
5 1/2" H, 4 1/4" Return 5 1/2" H, 7" Return
Available In All Finishes
(Sold in pairs)



2 1/4" European Bracket

23-224
4 5/8" H, 4 1/4" Return
Available In All Finishes
(Sold in pairs)



Wood & Metal Finishes:

- | | |
|-------------------|----------------------|
| Mahogany (03) | Linen (52) |
| Bronze (17) | Walnut (55) |
| Vintage Gold (23) | Unfinished (76) |
| Charcoal (40) | Mocha (955) |
| Black (45) | Platinum (960) |
| Black Walnut (47) | Antique Pewter (965) |
| White (50) | |



1 3/8" Metal Ceiling Bracket

10-255
5 3/8" Drop, 4" Base
Finishes: 17, 23, 45, 50
(Sold as each)



1 3/8" Metal Bracket

10-203
2 3/4" H, 3 1/2" - 4 1/2" Return
Finishes: 17, 23, 45, 50
(Sold as each)



1 3/8" Center Support Bracket

10-283
1 1/8" H, 3 1/2" Return
Finishes: 17, 23, 45, 50
(Sold as each)

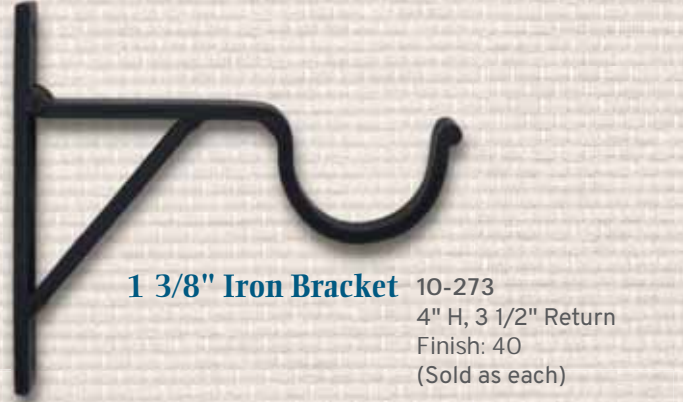

10-273
4" H, 3 1/2" Return
Finish: 40
(Sold as each)



10-296
4" H, 6 1/2" Pole Return
Finishes: 17, 23, 45, 50
(Sold as each)(Clip #93630 sold separately)

1 3/8" & 2 1/4" Metal Brackets



20-297
4" H, 7" Pole Return
Finishes: 17, 23, 45, 50
(Sold as each)(Clip #93630 sold separately)



2 1/4" Center Support Bracket

20-284
1 1/8" H x 4 1/4" Return
Finishes: 17, 23, 45, 50
(Sold as each)



2 1/4" Metal Bracket

20-204
2 3/4" H, 4" - 5 1/2" Return
Finishes: 17, 23, 45, 50
(Sold as each)



2 1/4" Iron Brackets

20-274
4" H, 4 1/4" Return
Finish: 40
(Sold as each)



2 1/4" Metal Ceiling Bracket

20-255
6 3/4" Drop, 4" Base
Finishes: 17, 23, 45, 50
(Sold as each)





Iron Image



1 3/8"

Iron Image

Iron Image offers the look of traditional wrought iron in 1 3/8" diameter wood poles, traverse rods and finials. The matte, charcoal finish gives the four finial designs and wood poles the look of forged iron. Authentic iron rings and brackets complete this Iron Image Collection.

CHARCOAL
40

1 3/8" Iron Image



Westwood Finial

13-138 - 1 3/8"
3 1/2" L x 2 3/4" H
(Sold in pairs)



Vesta End Cap

13-145 - 1 3/8"
1 3/4" L x 2 3/8" H
(Sold in pairs)



Ball Finial

13-101 - 1 3/8"
3 3/8" L x 2 3/8" H
(Sold in pairs)



Iron Rings

10-370 - 1 3/8"
1 3/4" I.D., 2 1/2" O.D.
(7 Rings per package)



Mission Finial

13-133 - 1 3/8"
3 1/2" L x 2 7/8" H
(Sold in pairs)



Iron Brackets

10-273 - 1 3/8"
4" H, 3 1/2" Return
(Sold as each)

Smooth Wood Poles 1 3/8"

- 11-004 4' Smooth Poles
- 11-006 6' Smooth Poles
- 11-008 8' Smooth Poles
- 11-012 12' Smooth Poles

Charcoal (40)





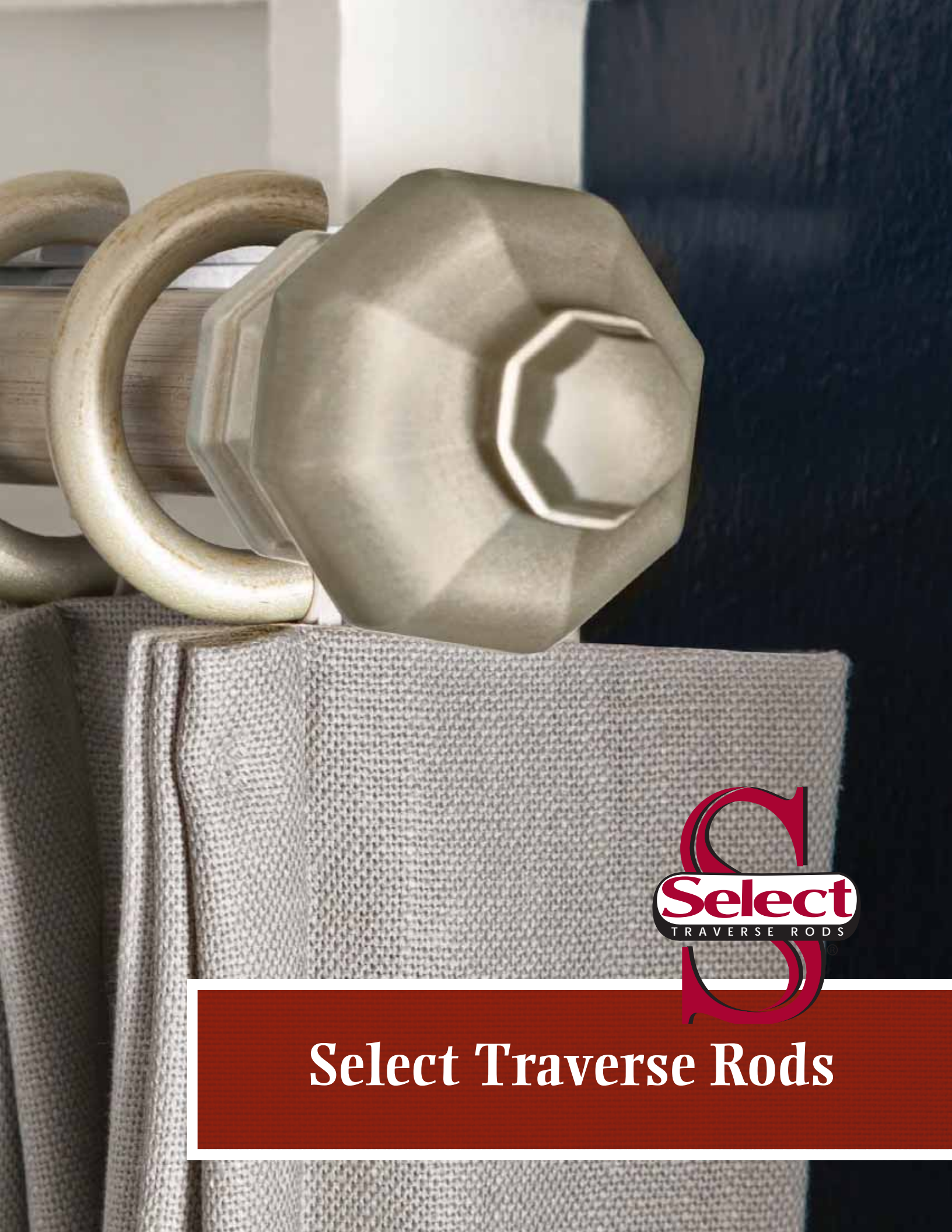

Select Traverse Rods



Select Traverse Rods

Select Wood Traverse Rods offer the beauty of a decorative wood pole with the functionality of a traverse rod.

Select Traverse Rods are available with 1 3/8" and 2 1/4" diameter wood fascia or with the option of 1 3/4" Flat Fascia.

Select Traverse Rods offer the option of two heavy duty track designs, Premium and Supreme. Both feature heavy duty tracks that are constructed with wheeled carriers and metal masters with the capacity to handle today's drapery treatments made with blackout linings and interlinings.

Select Wood Traverse Rods feature the following:

- All are assembled with heavy duty tracks allowing for a smooth operation.
- Select Premium and Supreme Tracks are available in the Bronze or Aluminum finish to coordinate with the fascia finish choice.
- Drapery weight for Select Premium and Supreme Traverse Rods – 4 lbs. per foot.
- Select Wood Traverse Rods are offered in 13 finish options.





1 3/8" & 2 1/4" Select Premium Traverse Rod Sets



Available with 1 3/8" and 2 1/4" diameter wood fascia in both Smooth and Reeded designs. The wheeled carriers allow a smooth operation for all drapery treatments. Also available with Flat Fascia, reference pages 35 and 36 for details.

- Select Premium track is available without wood fascia for a commercial or more contemporary look.
- Tracks are heavy duty and available in Bronze (17) or Aluminum (90).
- 1 3/8" and 2 1/4" are available with plain 2-wheeled carriers for Pinch Pleat or Ripplefold® draperies.
- 1 3/8" Premium Traverse Rods are available with Smooth Wood SureLock® Rings with 4-wheeled carriers. The SureLock® Traverse Rings simply snap into the 4-wheeled carriers for an easy installation. Ripplefold® is not available with the SureLock® Rings.
- Double Traverse Rod Set Options: available with back rod as "track only" or with 1 3/8" fascia attached. Rings are not available on the back rod.
- 1 3/8" and 2 1/4" Traverse Rod are available in 12 Select Wood Finishes.
- Iron Image, Charcoal Finish 40, is available in smooth 1 3/8" Traverse Rod Sets.



Ripplefold® is a registered trademark of Kirsch



2 1/4" Select Supreme Traverse Rod Sets

Traverse Rod Sets with Patented SureLock® Ring System

The Supreme track is used with the 2 1/4" wood fascia and features the patented SureLock® Decorative Ring System. SureLock® Traverse Rings simply snap into the 4-wheeled carriers for an easy installation. The SureLock® Rings and 4-wheeled carriers ensure the rings maintain a consistent appearance and allow a smooth operation.

Available in 12 Select Wood Finishes in both Smooth and Reeded Fascia.

The two decorative ring options available are the same design as the full round rings:

- Ribbed Wood Rings
- Bradford Resin Rings

Double Traverse Rod Set Options:

- Available with the back rod as "track only" or with 1 3/8" fascia attached.
- Rings are not available on the back track.



Patented SureLock® Ring System

Select Traverse Rods



Traverse Rod Sets

- Assembled to Order.*
- Maximum continuous set length - 14 ft.
(16 ft. available with a surcharge)
- Maximum set with Mitered Returns - 13 ft.
- Maximum set length - 28 ft. Must be 2-way draw.
- Mitered cuts are available for a surcharge.
- Cord draw standard.
- Hand draw option includes 36" White Fiberglass Baton. Additional baton options are available.
- Assembled set includes approximately 3.5 wheeled carriers or SureLock® Traverse Rings per foot, standard installation brackets (3"- 4" Return), center support bracket cover(s), and tension device.
- Ripplefold® available with Premium Track.
- Drapery weight – 4 lbs. per foot.
- Finials, End Caps, and Mitered Returns are not included. Please order separately.
- Double Traverse Rod Sets are available with back rod as "track only" or track with 1 3/8" fascia.

** Production time - 10 working days*

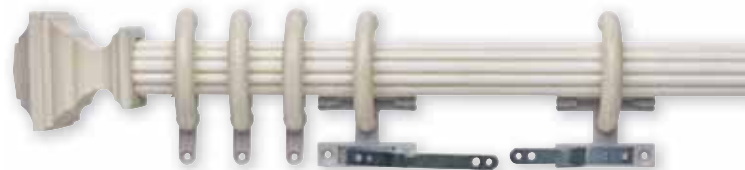

Select Wood Batons

53-470



Custom Mitered Return
with Fascia





Flat Fascia Traverse Rod Sets

Flat Fascia Traverse Rods offer a more contemporary design and are available in six Select Wood finishes. The fascia is 1 3/4" high and the rods are assembled with the Select Premium Track with Pinch Pleat or Ripplefold® carriers. Square Finials, Square Mitered Elbows, and Metal End Caps are available and must be ordered separately. Custom Mitered Returns are also available.

- Assembled with Premium Track using Plain Pinch Pleat or Ripplefold® Carriers.
- Wood finishes: White, Black, Bronze, Mocha, Platinum, and Unfinished.

Flat Fascia Traverse Rods are shipped with the Finials, End Caps, or Elbows attached.



Shown with Flat Fascia Square Wood Finial



Shown with Flat Fascia Square Metal End Cap



Shown with Flat Fascia Square Mitered Elbow



Shown with Flat Fascia Mitered Return

Select Traverse Rods



Square Wood Finial

23-169P
3" L x 2" H

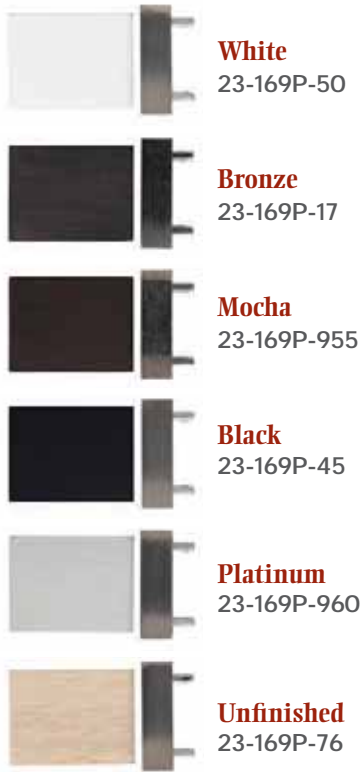

Collar (20-150) is required.
Collar sold separately.

Square Metal Collar

20-150



The collars are sold separately and available in Nickel (760) and Steel (767).

Square Mitered Elbow

23-468P
2 1/2" L x 2" H, 5 1/2" Maximum Return
Custom cut return available



Square Metal End Cap

20-154
1/2" L x 2" H
Nickel (760), Steel (767)

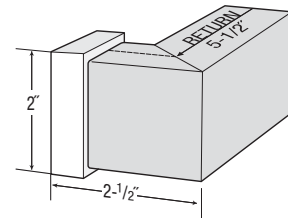

Square Mitered Elbow

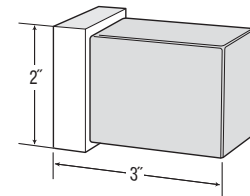

Square Wood Finial





Continuous Curved & Bent Traverse Rods

Select Wood offers traverse rods for bay, corner, or curved windows that can function as one continuous traverse rod around the bends or curves.

- Available with 1 3/8" or 2 1/4" Smooth or Reeded Fascia.
- Select Premium or Supreme Tracks are curved or bent according to the template.
- Resin Fascia is attached to the track and then a Select finish is applied. All Select Wood finishes are available to coordinate with Select Finials.
- Curved and bent rods are available with Pinch Pleat or Ripplefold® Carriers.
- Also available with 1 3/8" or 2 1/4" Select Wood SureLock® Rings. (Pinch Pleat Only)
- Curved or bent Select Premium Traverse Rod Sets without fascia are available for a commercial or more contemporary look.
- Templates are required.
- Curving, Bending, or Crating Fees may apply.



Select Traverse Rods



Custom Mitered Cut Traverse Rods for Bay and Corner Windows

The fascia for Select Wood Traverse Rods can be custom mitered cut to fit bay or corner windows. With this application each rod segment operates independently.

Mitered Cut Traverse Rods - Bay and Corner Windows

- Specify if wall or track measurement.
- Specify bracket return.
- A surcharge is applied for each miter cut.

Mitered Cut - Bay Windows

- Templates are required.
- Provide all required measurements and degrees of angles.

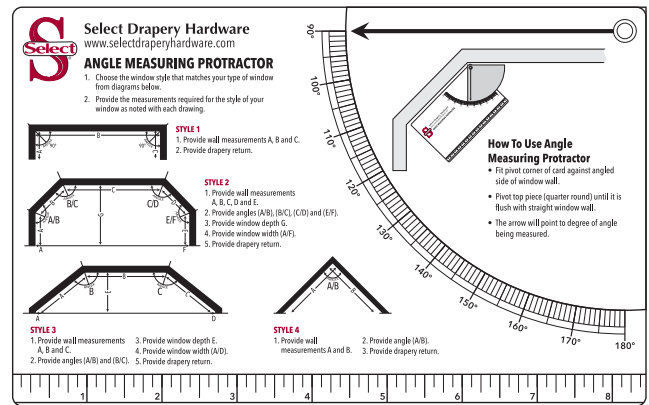

Select Protractor PRO-2016

Window Styles

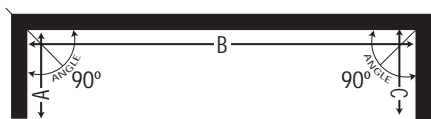

- STYLE 1**
1. Provide wall measurements A, B and C.
 2. Provide drapery return.

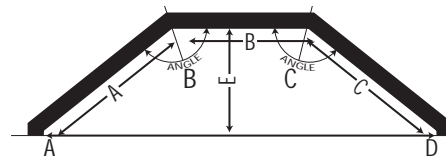

- STYLE 3**
1. Provide wall measurements A, B and C.
 2. Provide angles (B) and (C).
 3. Provide window depth E.
 4. Provide window width (A/D).
 5. Provide drapery return.

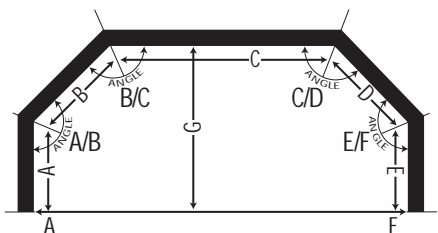

- STYLE 2**
1. Provide wall measurements A, B, C, D and E.
 2. Provide angles (A/B), (B/C), (C/D) and (E/F).
 3. Provide window depth G.
 4. Provide window width (A/F).
 5. Provide drapery return.

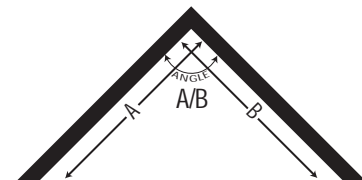

- STYLE 4**
1. Provide wall measurements A and B.
 2. Provide angle (A/B).
 3. Provide drapery return.

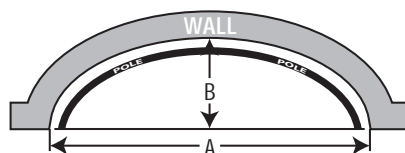

- Continuous Curve Window**
1. Provide wall measurements A and B.
 2. Provide drapery return.



Select Traverse Rods

Combination Brackets

1 3/8" and 2 1/4" Select Combination Brackets give the flexibility to install 1 3/8" or 2 1/4" full round pole with rings in front of a Traverse Rod.

The brackets offer the versatility of allowing the back rod to be:

- Back Rod Premium Track with 2 1/4" Wood Fascia.
- Back Rod Premium Track with 1 3/8" Wood Fascia.
- Back Rod Premium Track only.

Combination Brackets are available in 4 finishes:

- Black (45)
- Bronze (17)
- Vintage Gold (23)
- White (50)

Combination brackets must be specified when ordering the back traverse rod and are available with a surcharge.

Clips, #93630, are included when ordering with a Select Traverse Rod.

These brackets are designed for the installation of the front and back drapery to be at the same height when used with Select Premium Traverse Rod behind a Select Pole with Select Wood Rings.



**1 3/8" FULL ROUND POLE WITH
1 3/8" WOOD FASCIA TRAVERSE ROD AS BACK ROD**



**2 1/4" FULL ROUND POLE WITH
PREMIUM TRACK ONLY TRAVERSE ROD AS BACK ROD**



**1 3/8" Pole & Traverse Rod Combination Bracket
10-296**

Bracket must be specified with order.

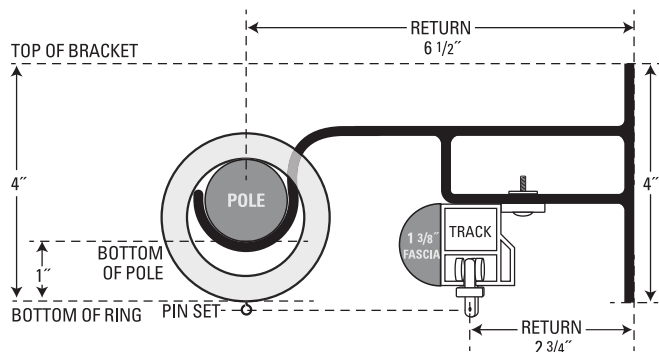

**2 1/4" Pole & Traverse Rod Combination Bracket
20-297**

Bracket must be specified with order.

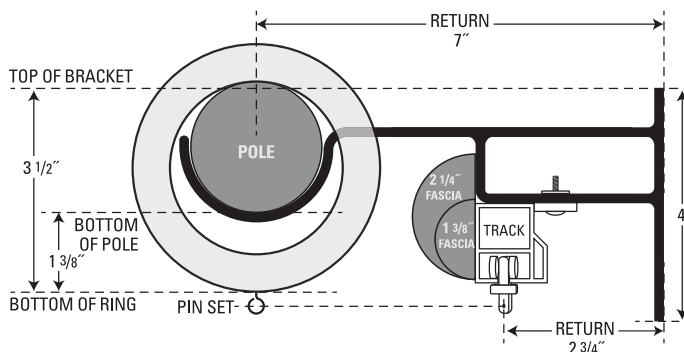

Select Traverse Rods



Brackets

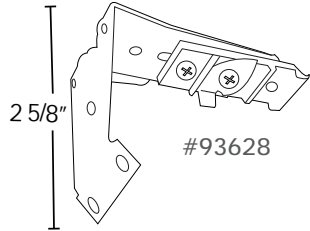

Standard Wall End Bracket

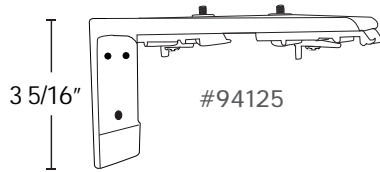

Double Wall Bracket
or 6" Projection Bracket

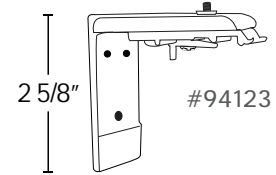

Heavy Duty Single
Wall Bracket

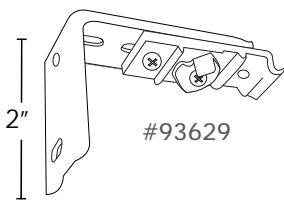

Standard Center
Support Bracket

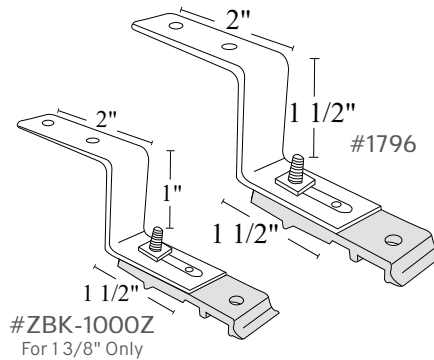

Ceiling Mount Brackets

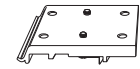

Track Splice
#93633



Support Cover
#93699

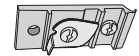

Mounting Clip
#93630

Bracket Details

Description	Item No.	Finishes	Returns
Standard Wall End Bracket	93628	025, 85	3" - 4" Return
Standard Center Support Bracket	93629	025, 85	3" - 4" Return
Ceiling / Mounting Clip for Select Traverse Rods	93630	17, 45, 90	
Track Splice	93633	17, 90	
Center Support Cover	93699	025	
Heavy Duty Single Wall Bracket **	94123	025, 85, 90	3 1/2" - 4 1/2" Return
Double or 6" Projection Bracket **	94125	025, 85, 90	5 1/2" Return
Ceiling Mount Bracket - 1 1/2" Drop **	1796	61	1 1/2" Drop
Ceiling Mount Bracket - 1" Drop **	ZBK-1000Z		1" Drop
1 3/8" Pole / Traverse Combination Bracket **	10-296	17, 23, 45, 50	6 1/2" Pole Return
2 1/4" Pole / Traverse Combination Bracket **	20-297	17, 23, 45, 50	7" Pole Return

** Mounting Clips (93630) are not included when purchased separately

Finishes: Bronze (17 & 85) • Vintage Gold (23) • White (025 & 50) • Black (45) • Zinc (61) • Aluminum (90)



Select Traverse Rods

Specify the Following When Ordering Traverse Rods:

- Quantity
- Fascia Style (Smooth, Reeded, or Flat)
- Finish
- Track Width
- Draw (Right, Left or Center)
- Pinch Pleat or Ripplefold®
- Ripplefold® - specify fullness and Overlap or Butt Master
- Cord Placement and Drop (Standard 8 ft.)
- Wall or Ceiling Mount
- Return (If other than 3 1/2" additional charges may apply)
- Order Finials or End Caps Separately



Brackets Supplied with Traverse Rod

Brackets and supports included, determined by rod length:

Up to 48"	2 End Brackets
49" to 90"	2 End Brackets; 1 Center Support Bracket
91" to 138"	2 End Brackets; 2 Center Support Brackets
139" to 174"	2 End Brackets; 3 Center Support Brackets
175" to 192"	2 End Brackets; 4 Center Support Brackets

Masters

Premium Traverse Rod Masters & Carriers

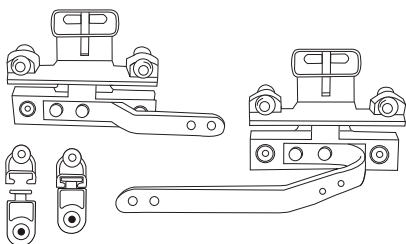

Traverse Rod Masters & SureLock® Rings

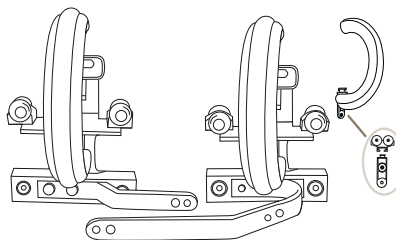

Premium Ripplefold® Overlap Master

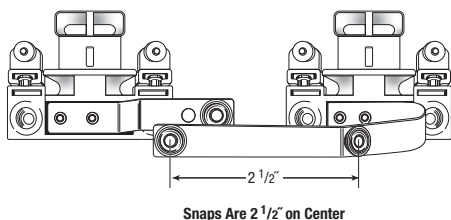

Premium Ripplefold® Butt Master

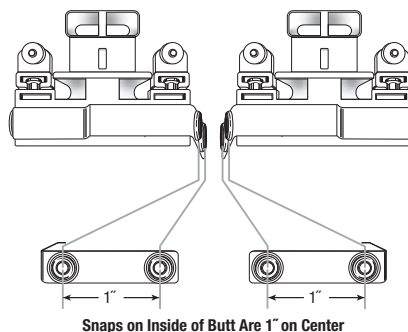

Center of Snap Locations

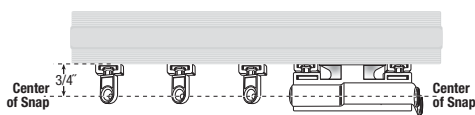

Custom Cut Mitered Returns

- Available with all Select Traverse Rods.
- Order by track width. See drawing.
- Specify drapery return.

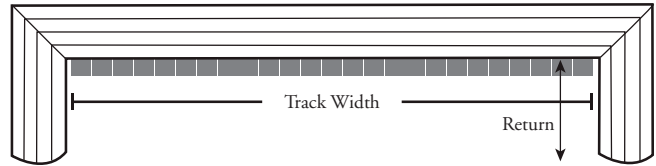

SQUARE MITERED ELBOW

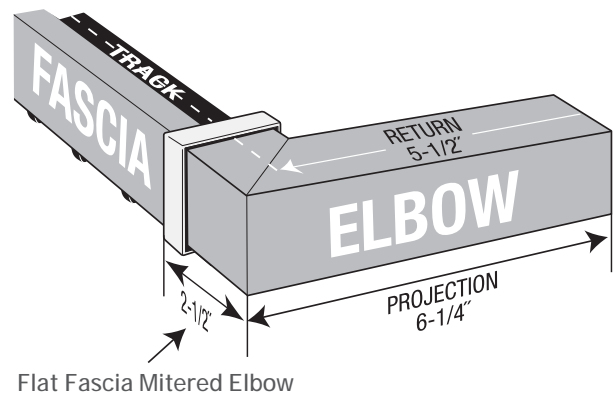
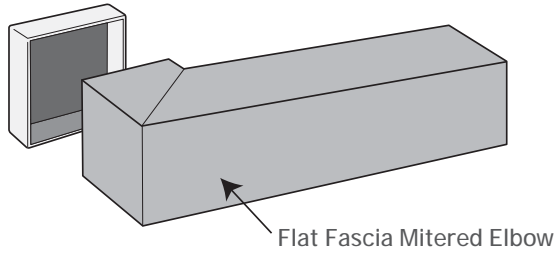

SQUARE WOOD FINIAL

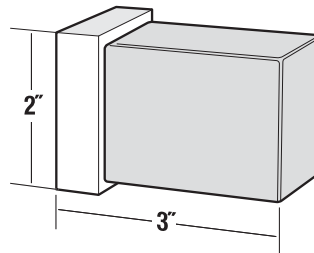
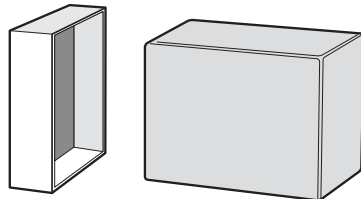

CUSTOM MITERED RETURN WITH FASCIA



WARNING
ADVERTENCIA

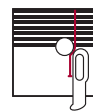

Window Treatment Cord Can STRANGLE Your Child. To prevent strangulation, purchase cordless products with inaccessible cords.

La cuerda de la persiana puede ESTRANGULAR a su niño. Para evitar el estrangulamiento, compre alternativas cuerdo o productos con cuerdas inaccesibles.

Ripplefold® is a registered trademark of Kirsch
SureLock® is a registered trademark of Select Drapery Hardware



Displays & Sales Aids

Select Sales Aids

Item No.	Description
2019SWB	Select Product Binder Includes: Select Wood Brochure, Wholesale Price List, and Finish Samples Select Metal Brochure, Wholesale Price List and Finish Samples
2018SEL	Select Wood Collection Finish Selector Includes: 13 Finishes on 6" Slats
2019SSC	Select Wood Sample Case Includes: 5 Finial Designs, 1 End Cap, 1 Holdback, 5 Rings, Pole Samples, Finish Selector (2018SEL), Brochure & Price List
2019SELB	Select Color Brochure
2019SPL	Select Wholesale Price List

Select Displays

Item No.	Description	Dimension
2019SADK	1 3/8" & 2 1/4" Select Wood Wall Display Features: 4 - 1 3/8" Poles; 2 - 2 1/4" Poles; 12 Decorative Finial Designs 6 Finishes - Antique Pewter, Black, Bronze, Charcoal, Linen & Platinum Includes Mounting Rails and Signage	30" W X 46" H
2019SBDK	1 3/8" & 2 1/4" Select Wood Wall Display Features: 3 - 1 3/8" Poles; 3 - 2 1/4" Poles; 12 Decorative Finial Designs 6 Finishes - Black Walnut, Mahogany, Mocha, Vintage Gold, Walnut & White Includes Mounting Rails and Signage	30" W X 46" H
2019STDK	1 3/8" & 2 1/4" Select Wood Traverse Rod Wall Display Features: 3 - 2 1/4" Rods; 2 - 1 3/8" Rod, & 1 Flat Fascia Traverse Rod 11 Finial Designs & 1 End Cap Design 6 Finishes - Antique Pewter, Black Walnut, Bronze, Linen, Mocha & Platinum Includes Mounting Rails and Signage	30" W X 46" H
2016SDR	Select Wall Display Rails - Includes 12 Black Mounting Blocks	37 1/2" H

Displays & Sales Aids



2019SADK



2019SBDK



2019STDK



2018SEL



Select Sample Case
2019SSC



Select Product Binder
2019SWB



Ordering Information

Placing Your Order

The color photos in this brochure are a close representation of the finishes available. Finishes are hand finished so there may be color variations. Please refer to your Select Wood Finish Selector #2018SEL or the Select Product Binder #2019SWB for actual samples of the finishes.

1 3/8" Finials are packaged in pairs. The 2 1/4" Finials are packaged as each.

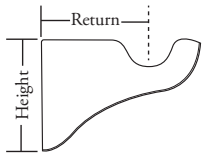

Traditional Bracket

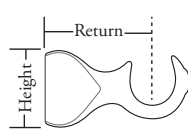

European Bracket

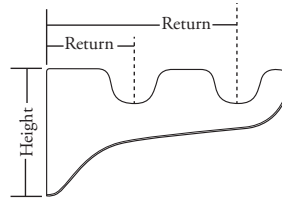

Double Bracket

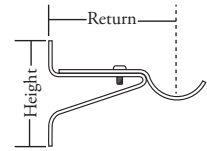

Metal Bracket

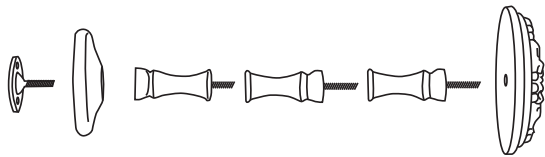

Holdback

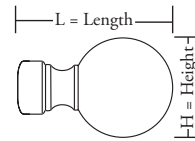

Finial

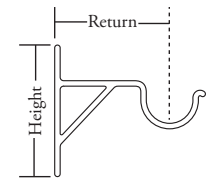

Iron Bracket

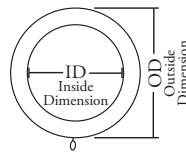

Ring

Lifetime Limited Warranty

Selective Enterprises, Inc. provides a lifetime limited warranty on all Select Drapery Hardware and Select Traverse Rods. Selective Enterprises, Inc. warrants that these products will be free from defects due to faulty workmanship or materials. This warranty extends to the original residential retail purchaser.

If a Selective Enterprises, Inc. product is found to be defective during the warranty period, we will at our discretion repair or replace the defective product at no charge. Repair or replacement of defective products is the sole remedy under this warranty and in no event shall Selective Enterprises, Inc. be liable for costs to remove, replace, transport or reinstall or incidental or consequential damages.

This warranty does not cover normal wear and tear or any damage or loss by accidents, alterations, improper use, abuse, neglect, or improper installation, cleaning or other maintenance. The warranty shall be void if product is moved from its original installed location. Select products may gradually lose color intensity after long exposure to direct sun. This color loss is not covered by the warranty. All cords eventually wear out. This is considered normal wear and tear not covered by warranty. The warranty does not cover removal, installation, replacement, or shipping costs.



SELECT METAL COLLECTION

www.selectdraperyhardware.com

Select Drapery Hardware also includes the Select Metal Collection which is a premium collection of metal poles, accessories, and traverse rods. This collection offers a choice of eight stunning finishes in two diameters, 3/4" and 1 3/16".

The Select Metal Collection is included in the Select Drapery Hardware Product Binder, 2019SWB, and can also be viewed on the Select Drapery Hardware website.



